

LM3526 Dual Port USB Power Switch and Over-Current Protection

Check for Samples: [LM3526](#)

FEATURES

- **Compatible with USB1.1 and USB 2.0**
- **1 ms Fault Flag Delay Filters Hot-Plug Events**
- **Smooth Turn-on Eliminates In-rush Induced Voltage Drop**
- **UL Recognized Component: REF# 205202**
- **1A Nominal Short Circuit Output Current Protects PC Power Supplies**
- **Thermal Shutdown Protects Device in Direct Short Condition**
- **500mA Minimum Continuous Load Current**
- **Small SOIC-8 package minimizes board space**
- **2.7V to 5.5V Input Voltage Range**
- **140 mΩ Max. Switch Resistance**
- **1 μA Max. Standby Current**
- **200 μA Max. Operating Current**
- **Under-voltage Lockout (UVLO)**

APPLICATIONS

- **Universal Serial Bus (USB) Root Hubs including Desktop and Notebook PC**
- **USB Monitor Hubs**
- **Other Self-Powered USB Hub Devices**
- **High Power USB Devices Requiring In-rush Limiting**
- **General Purpose High Side Switch Applications**

DESCRIPTION

The LM3526 provides Universal Serial Bus standard power switch and over-current protection for all host port applications. The dual port device is ideal for Notebook and desktop PC's that supply power to more than one port.

A 1 ms delay on the fault flag output prevents erroneous overcurrent reporting caused by in-rush currents during hot-plug events.

The dual stage thermal protection circuit in the LM3526 provides individual protection to each switch and the entire device. In a short-circuit/over-current event, the switch dissipating excessive heat is turned off, allowing the second switch to continue to function uninterrupted.

The LM3526 accepts an input voltage between 2.7V and 5.5V allowing use as a device-based in-rush current limiter for 3.3V USB peripherals, as well as Root and Self-Powered Hubs at 5.5V. The Enable inputs accept both 3.3V and 5.0V logic thresholds.

The small size, low R_{ON} , and 1 ms fault flag delay make the LM3526 a good choice for root hubs as well as per-port power control in embedded and stand-alone hubs.



Please be aware that an important notice concerning availability, standard warranty, and use in critical applications of Texas Instruments semiconductor products and disclaimers thereto appears at the end of this data sheet.

All trademarks are the property of their respective owners.



These devices have limited built-in ESD protection. The leads should be shorted together or the device placed in conductive foam during storage or handling to prevent electrostatic damage to the MOS gates.

Typical Operating Circuit and Connection Diagram

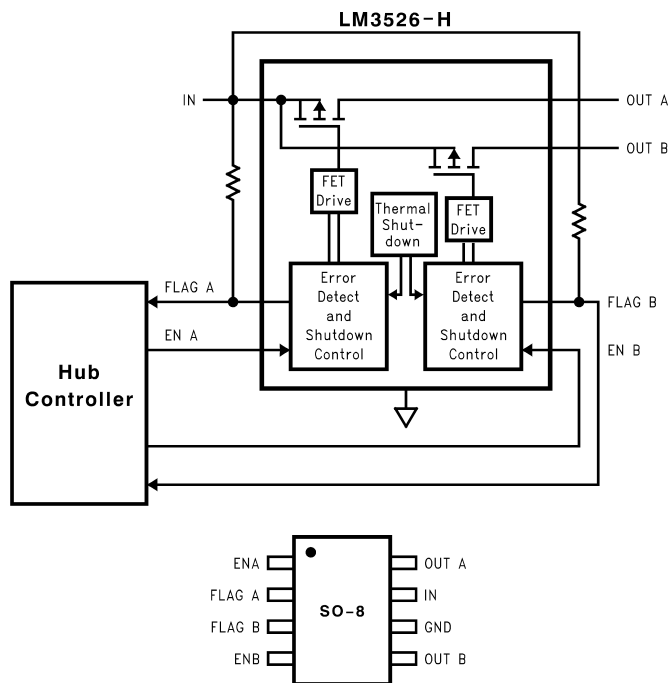

Figure 1. LM3526-H

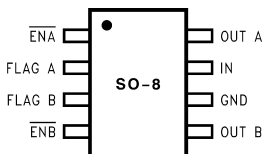

Figure 2. LM3526-L

Absolute Maximum Ratings⁽¹⁾⁽²⁾

Supply Voltage	-0.3V to 6V
Output Voltage	-0.3V to 6V
Voltage at All Other Pins	-0.3V to 5.5V
Power Dissipation ($T_A = 25^\circ\text{C}$) ⁽³⁾	700 mW
T_{JMAX} ⁽³⁾	150°C

- (1) Absolute Maximum Ratings indicate limits beyond which damage to the device may occur. Electrical specifications do not apply when operating the device beyond its rated operating conditions.
- (2) If Military/Aerospace specified devices are required, please contact the Texas Instruments Sales Office/Distributors for availability and specifications.
- (3) The maximum power dissipation must be derated at elevated temperatures and is dictated by T_{JMAX} (Maximum junction temperature), θ_{JA} (junction to ambient thermal resistance), and T_A (ambient temperature). The maximum allowable power dissipation at any temperature is $P_{DMAX} = (T_{JMAX} - T_A)/\theta_{JA}$ or the number given in the Absolute Maximum Ratings, whichever is lower. $\theta_{JA} = 150^\circ\text{C/W}$.

Operating Ratings

Supply Voltage Range	2.7V to 5.5V
Operating Ambient Range	-40°C to 85°C
Operating Junction Temperature Range	-40°C to 125°C
Storage Temperature Range	-65°C to +150°C
Lead Temperature (Soldering, 5 seconds)	260°C
ESD Rating ⁽¹⁾	2kV
ESD Rating Output Only	8kV

- (1) The human body model is a 100 pF capacitor discharged through a 1.5 k Ω resistor into each pin. Enable pin ESD threshold is 1.7kV.

DC Electrical Characteristics

Limits in standard typeface are for $T_J = 25^\circ\text{C}$, and limits in **boldface** type apply over the full operating temperature range. Unless otherwise specified: $V_{IN} = 5.0\text{V}$, $V_{EN} = 0\text{V}$ (LM3526-L) or $V_{EN} = V_{IN}$ (LM3526-H).

Symbol	Parameter	Conditions	Min	Typ	Max	Units
R_{ON}	On Resistance	$V_{IN} = 5\text{V}$, $I_{OUT} = 500\text{mA}$, each switch		100	140	m Ω
		$V_{IN} = 2.7\text{V}$, $I_{OUT} = 500\text{mA}$, each switch		110	180	
I_{OUT}	OUT pins continuous output current	Each Output	0.5			A
I_{SC}	Short Circuit Output Current	Each Output (enable into Load) ⁽¹⁾				A
		$V_{OUT} = 4.0\text{V}$ $V_{OUT} = 0.1\text{V}$	0.5	1.2 1	1.9 1.5	
OC_{THRESH}	Over-current Threshold			2.2	3.2	A
I_{LEAK}	OUT pins Output Leakage Current	$V_{EN} = V_{IN}$ (LM3526-L) $V_{EN} = 0\text{V}$ (LM3526-H)		0.01	10	μA
R_{FO}	FLAG Output Resistance	$I_{FO} = 10\text{ mA}$, $V_{IN} = 5.0\text{V}$		10	25	Ω
		$I_{FO} = 10\text{ mA}$, $V_{IN} = 3.3\text{V}$		11	35	
		$I_{FO} = 10\text{ mA}$, $V_{IN} = 2.7\text{V}$		12	40	
I_{EN}	\overline{EN}/EN Leakage Current	$V_{EN}/V_{EN} = 0\text{V}$ or $V_{EN}/V_{EN} = V_{IN}$	-0.5		0.5	μA
V_{IH}	\overline{EN}/EN Input Logic High	See ⁽²⁾	2.4	1.9		V
V_{IL}	\overline{EN}/EN Input Logic Low	See ⁽²⁾		1.7	0.8	V
V_{UVLO}	Under-Voltage Lockout Threshold			1.8		V
I_{DDOFF}	Supply Current	Switch-Off		0.2	1	μA
		-40°C $\leq T_J \leq$ 85°C			2	
I_{DDON}	Supply Current	Switch-On		115	200	μA
T_{HSD}	Over-temperature Shutdown Threshold	T_J Increasing, with no shorted output		150		°C
		T_J Increasing, with shorted output (s)		145		
		T_J Decreasing ⁽¹⁾		135		

- (1) Thermal Shutdown will protect the device from permanent damage.

- (2) For LM3526-L, OFF is $\overline{EN} \geq 2.4\text{V}$ and ON is $\overline{EN} \leq 0.8\text{V}$. For LM3526-H, OFF is $\overline{EN} \leq 0.8\text{V}$ and ON is $\overline{EN} \geq 2.4\text{V}$.

DC Electrical Characteristics (continued)

Limits in standard typeface are for $T_J = 25^\circ\text{C}$, and limits in **boldface** type apply over the full operating temperature range. Unless otherwise specified: $V_{IN} = 5.0\text{V}$, $V_{\overline{EN}} = 0\text{V}$ (LM3526-L) or $V_{EN} = V_{IN}$ (LM3526-H).

Symbol	Parameter	Conditions	Min	Typ	Max	Units
I_{FH}	Error Flag Leakage Current	$V_{flag} = 5\text{V}$		0.01	1	μA

AC Electrical Characteristics

Limits in standard typeface are for $T_J = 25^\circ\text{C}$, and limits in **boldface** type apply over the full operating temperature range. Unless otherwise specified: $V_{IN} = 5.0\text{V}$.

Symbol	Parameter	Conditions	Min	Typ	Max	Units
t_r	OUT Rise Time	$R_L = 10\Omega$		100		μs
t_f	OUT Fall Time	$R_L = 10\Omega$		5		μs
t_{ON}	Turn on Delay, \overline{EN} to OUT	$R_L = 10\Omega$		150		μs
t_{OFF}	Turn off Delay, \overline{EN} to OUT	$R_L = 10\Omega$		5		μs
t_{OC}	Over Current Flag Delay	$R_L = 0$		1		ms

TYPICAL APPLICATION CIRCUIT

PIN DESCRIPTIONS

Pin Number	Pin Name	Pin Function
1, 4	\overline{ENA} , \overline{ENB} (LM3526-L) ENA, ENB (LM3526-H)	Enable (Input): Logic-compatible enable inputs.
2, 3	FLAG A FLAG B	Fault Flag (Output): Active-low, open-drain outputs. Indicates overcurrent, UVLO or thermal shutdown. *See Application Information for more information.
6	GND	Ground
7	IN	Supply Input: This pin is the input to the power switch and the supply voltage for the IC.
8, 5	OUT A OUT B	Switch Output: These pins are the outputs of the high side switch.

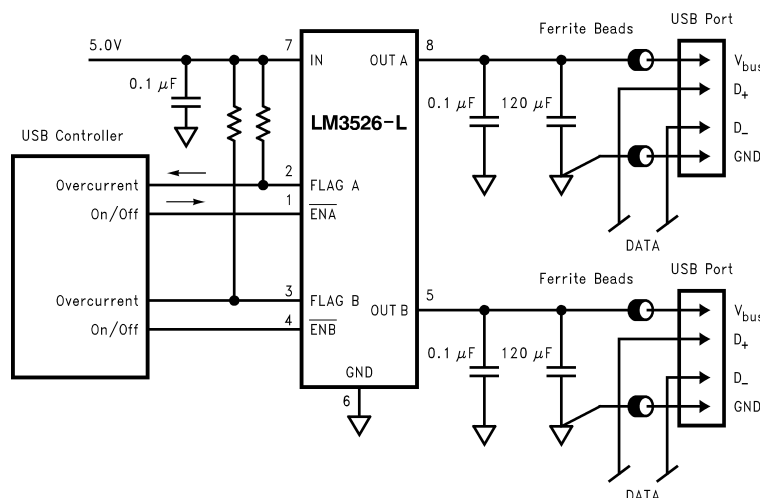
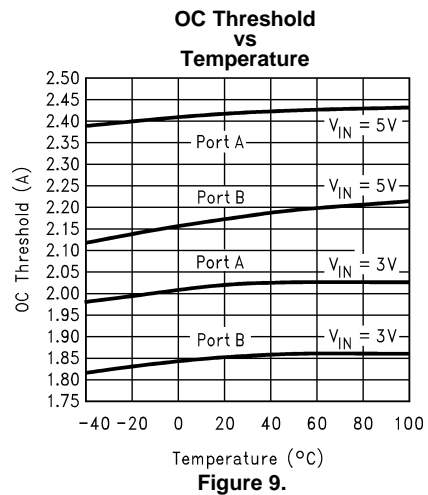
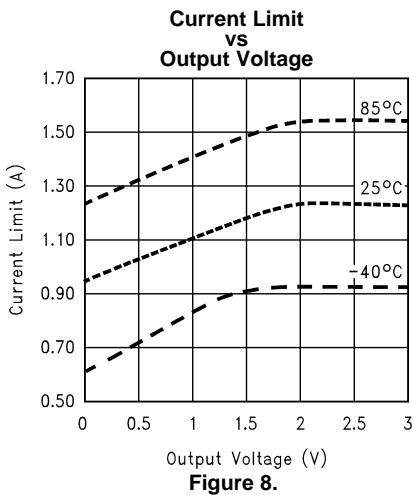
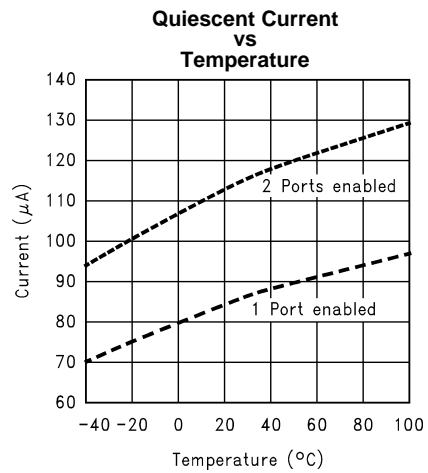
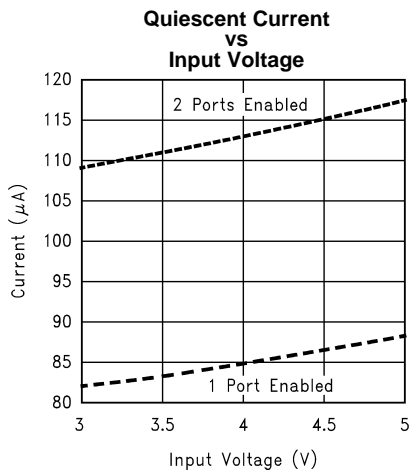
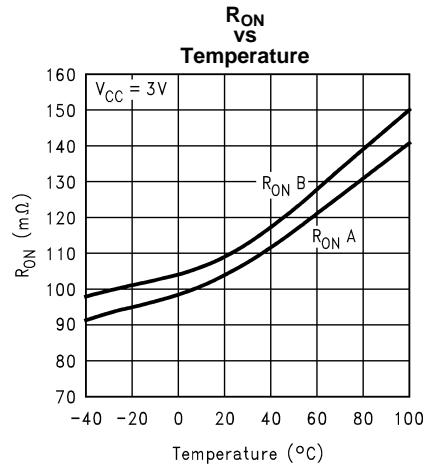
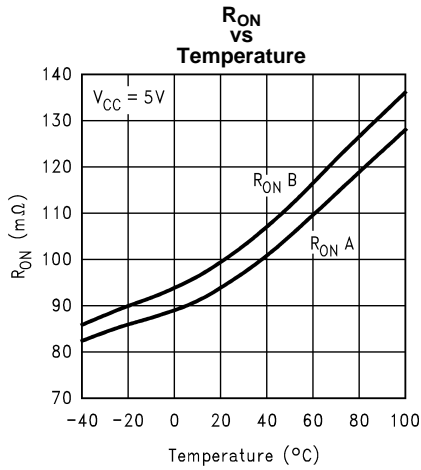

Figure 3. Typical Application Circuit

Typical Performance Characteristics

$V_{IN} = 5.0V$, $I_L = 500\text{ mA}$, $T_A = 25^\circ\text{C}$ unless otherwise specified.



Typical Performance Characteristics (continued)

$V_{IN} = 5.0V$, $I_L = 500\text{ mA}$, $T_A = 25^\circ\text{C}$ unless otherwise specified.

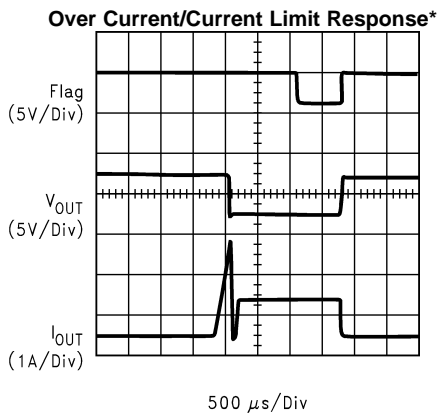
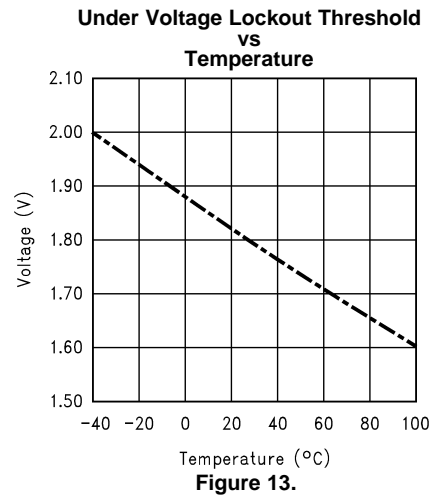
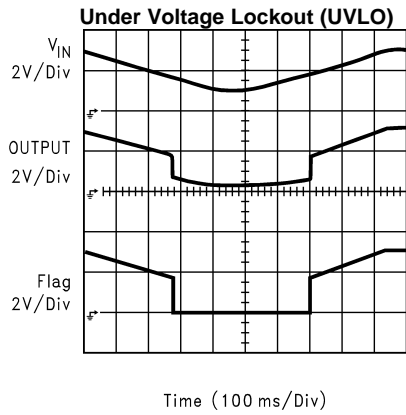
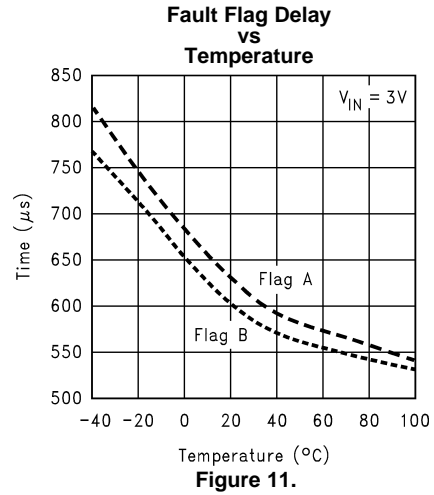
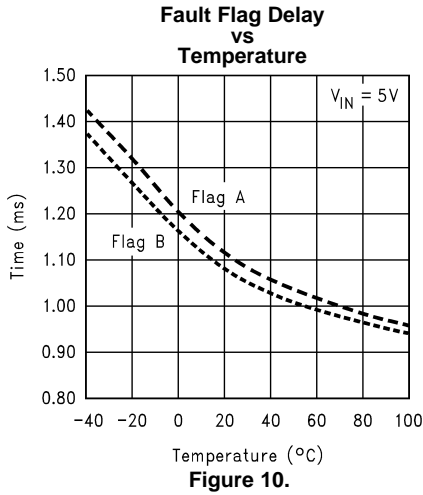

* Output is shorted to Ground through a 100 mΩ resistor

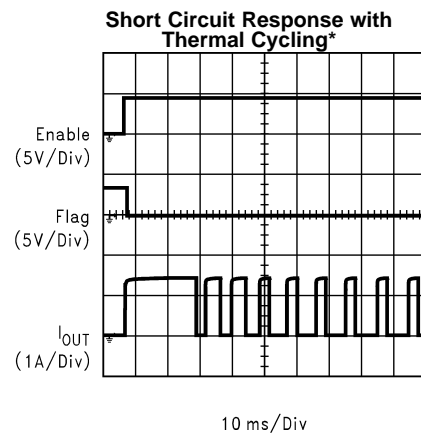

Typical Performance Characteristics (continued)

$V_{IN} = 5.0V$, $I_L = 500\text{ mA}$, $T_A = 25^\circ\text{C}$ unless otherwise specified.

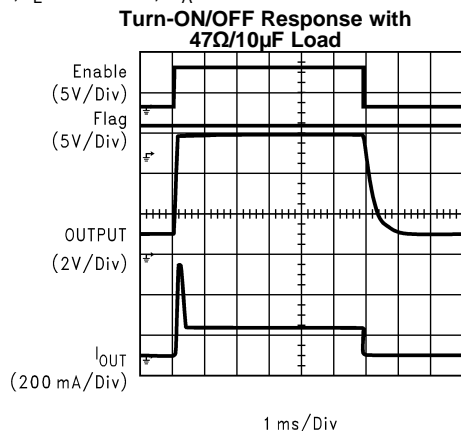

Figure 16.

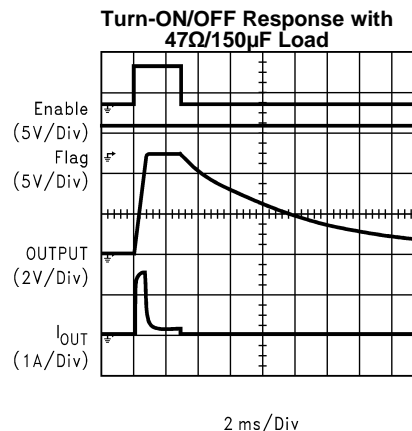

Figure 17.

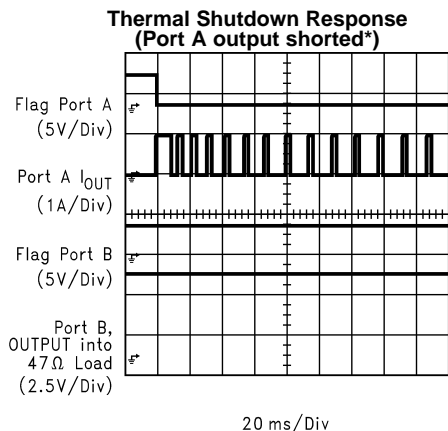

Figure 18.

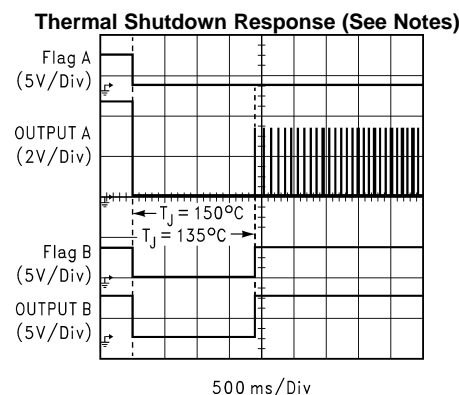

Figure 19.

* Port A is shorted to GND through a 100 mΩ resistor

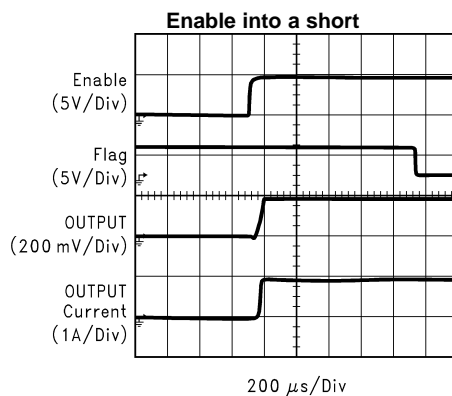

Figure 20.

FUNCTIONAL DESCRIPTION

The LM3526-H and LM3526-L are high side P-Channel switches with active-high and active-low enable inputs, respectively. Fault conditions turn-off and inhibit turn-on of the output transistor and activate the open-drain error flag transistor sinking current to the ground.

INPUT AND OUTPUT

IN (Input) is the power supply connection to the control circuitry and the source of the output MOSFET.

OUT (Output) is the connection to the drain of the output MOSFET. In a typical application circuit, current flows through the switch from IN to OUT towards the load.

If V_{OUT} is greater than V_{IN} when the switch is enabled, current will flow from OUT to IN since the MOSFET is bidirectional.

THERMAL SHUTDOWN

The LM3526 is internally protected against excessive power dissipation by a two-stage thermal protection circuit. If the device temperature rises to approximately 145°C, the thermal shutdown circuitry turns off any switch that is current limited. Non-overloaded switches continue to function normally. If the die temperature rises above 150°C, both switches are turned off and both fault flag outputs are activated. Hysteresis ensures that a switch turned off by thermal shutdown will not be turned on again until the die temperature is reduced to 135°C. Shorted switches will continue to cycle off and on, due to the rising and falling die temperature, until the short is removed.

UNDERVOLTAGE LOCKOUT

UVLO prevents the MOSFET switch from turning on until input voltage exceeds 1.8V (typical).

If input voltage drops below 1.8V (typical), UVLO shuts off the MOSFET switch and signals the fault flag. UVLO functions only when device is enabled.

CURRENT LIMIT

The current limit circuit is designed to protect the system supply, the MOSFET switches and the load from damage caused by excessive currents. The current limit threshold is set internally to allow a minimum of 500 mA through the MOSFET but limits the output current to approximately 1.0A typical.

FAULT FLAG

The fault flag is an open-drain output capable of sinking 10 mA load current to typically 100 mV above ground.

A parasitic diode exists between the flag pins and V_{IN} pin. Pulling the flag pins to voltages higher than V_{IN} will forward bias this diode and will cause an increase in supply current. This diode will also clamp the voltage on the flag pins to a diode drop above V_{IN} .

The fault flag is active (pulled low) when any of the following conditions are present: under-voltage, current limit, or thermal shutdown.

A 1ms (typ.) delay in reporting the fault condition prevents erroneous fault flags and eliminates the need for an external RC delay network.

Application Information

FILTERING

The USB specification indicates that “no less than 120 μ F tantalum capacitors” must be used on the output of each downstream port. This bulk capacitance provides the short-term transient current needed during a hot plug-in. Current surges caused by the input capacitance of the down stream device could generate undesirable EMI signals. Ferrite beads in series with all power and ground lines are recommended to eliminate or significantly reduce EMI.

In selecting a ferrite bead, the DC resistance of the wire used must be kept to a minimum to reduce the voltage drop.

A 0.01 μF ceramic capacitor is recommended on each port directly between the V_{BUS} and ground pins to prevent EMI damage to other components during the hot-detachment.

Adequate capacitance must be connected to the input of the device to limit the input voltage drop during a hot-plug event to less than 330 mV. For a few tens of μs , the host must supply the in-rush current to the peripheral, charging its bulk capacitance to V_{BUS} . This current is initially supplied by the input capacitor. A 33 μF 16V tantalum capacitor is recommended.

In choosing the capacitors, special attention must be paid to the Effective Series Resistance, ESR, of the capacitors to minimize the IR drop across the capacitor's ESR.

SOFT START

To eliminate the upstream voltage droop caused by the high in-rush current drawn by the output capacitors, the maximum in-rush current is internally limited to 1.5A.

TRANSIENT OVER-CURRENT DELAY

High transient current is also generated when the switch is enabled and large values of capacitance at the output have to be rapidly charged. The in-rush currents created could exceed the short circuit current limit threshold of the device forcing it into the current limit mode. The capacitor is charged with the maximum available short circuit current set by the LM3526. The duration of the in-rush current depends on the size of the output capacitance and load current. Since this is not a valid fault condition, the LM3526 delays the generation of the fault flag for 1 ms. If the condition persists due to other causes such as a short, a fault flag is generated after a 1 ms delay has elapsed.

The LM3526's 1 ms delay in issuing the fault flag is adequate for most applications. If longer delays are required, an RC filter as shown in [Figure 21](#) may be used.

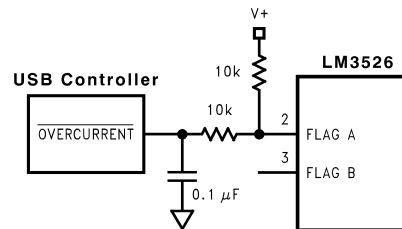

Figure 21.

PCB LAYOUT CONSIDERATIONS

In order to meet the USB requirements for voltage drop, droop and EMI, each component used in this circuit must be evaluated for its contribution to the circuit performance. The PCB layout rules and guidelines must be followed.

- Place the switch as close to the USB connector as possible. Keep all V_{BUS} traces as short as possible and use at least 50-mil, 1 ounce copper for all V_{BUS} traces. Solder plating the traces will reduce the trace resistance.
- Avoid vias as much as possible. If vias are used, use multiple vias in parallel and/or make them as large as possible.
- Place the output capacitor and ferrite beads as close to the USB connector as possible.
- If ferrite beads are used, use wires with minimum resistance and large solder pads to minimize connection resistance.

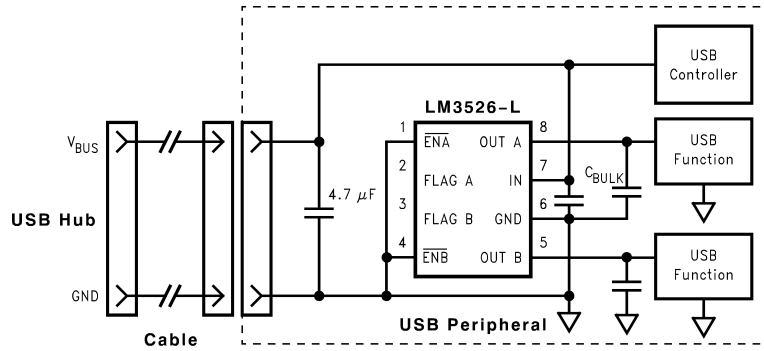

Figure 25. In-rush Current-limit Application

REVISION HISTORY

Changes from Revision D (March 2013) to Revision E	Page
• Changed layout of National Data Sheet to TI format	11

PACKAGING INFORMATION

Orderable Device	Status (1)	Package Type	Package Drawing	Pins	Package Qty	Eco Plan (2)	Lead/Ball Finish (6)	MSL Peak Temp (3)	Op Temp (°C)	Device Marking (4/5)	Samples
LM3526M-H	NRND	SOIC	D	8	95	TBD	Call TI	Call TI	-40 to 125	3526 M-H	
LM3526M-H/NOPB	ACTIVE	SOIC	D	8	95	Green (RoHS & no Sb/Br)	CU SN	Level-1-260C-UNLIM	-40 to 125	3526 M-H	Samples
LM3526M-L	NRND	SOIC	D	8	95	TBD	Call TI	Call TI	-40 to 125	3526 M-L	
LM3526M-L/NOPB	ACTIVE	SOIC	D	8	95	Green (RoHS & no Sb/Br)	CU SN	Level-1-260C-UNLIM	-40 to 125	3526 M-L	Samples
LM3526MX-H/NOPB	ACTIVE	SOIC	D	8	2500	Green (RoHS & no Sb/Br)	CU SN	Level-1-260C-UNLIM	-40 to 125	3526 M-H	Samples
LM3526MX-L	NRND	SOIC	D	8	2500	TBD	Call TI	Call TI	-40 to 125	3526 M-L	
LM3526MX-L/NOPB	ACTIVE	SOIC	D	8	2500	Green (RoHS & no Sb/Br)	CU SN	Level-1-260C-UNLIM	-40 to 125	3526 M-L	Samples

(1) The marketing status values are defined as follows:

ACTIVE: Product device recommended for new designs.

LIFEBUY: TI has announced that the device will be discontinued, and a lifetime-buy period is in effect.

NRND: Not recommended for new designs. Device is in production to support existing customers, but TI does not recommend using this part in a new design.

PREVIEW: Device has been announced but is not in production. Samples may or may not be available.

OBSELETE: TI has discontinued the production of the device.

(2) Eco Plan - The planned eco-friendly classification: Pb-Free (RoHS), Pb-Free (RoHS Exempt), or Green (RoHS & no Sb/Br) - please check <http://www.ti.com/productcontent> for the latest availability information and additional product content details.

TBD: The Pb-Free/Green conversion plan has not been defined.

Pb-Free (RoHS): TI's terms "Lead-Free" or "Pb-Free" mean semiconductor products that are compatible with the current RoHS requirements for all 6 substances, including the requirement that lead not exceed 0.1% by weight in homogeneous materials. Where designed to be soldered at high temperatures, TI Pb-Free products are suitable for use in specified lead-free processes.

Pb-Free (RoHS Exempt): This component has a RoHS exemption for either 1) lead-based flip-chip solder bumps used between the die and package, or 2) lead-based die adhesive used between the die and leadframe. The component is otherwise considered Pb-Free (RoHS compatible) as defined above.

Green (RoHS & no Sb/Br): TI defines "Green" to mean Pb-Free (RoHS compatible), and free of Bromine (Br) and Antimony (Sb) based flame retardants (Br or Sb do not exceed 0.1% by weight in homogeneous material)

(3) MSL, Peak Temp. - The Moisture Sensitivity Level rating according to the JEDEC industry standard classifications, and peak solder temperature.

(4) There may be additional marking, which relates to the logo, the lot trace code information, or the environmental category on the device.

⁽⁵⁾ Multiple Device Markings will be inside parentheses. Only one Device Marking contained in parentheses and separated by a "-" will appear on a device. If a line is indented then it is a continuation of the previous line and the two combined represent the entire Device Marking for that device.

⁽⁶⁾ Lead/Ball Finish - Orderable Devices may have multiple material finish options. Finish options are separated by a vertical ruled line. Lead/Ball Finish values may wrap to two lines if the finish value exceeds the maximum column width.

Important Information and Disclaimer:The information provided on this page represents TI's knowledge and belief as of the date that it is provided. TI bases its knowledge and belief on information provided by third parties, and makes no representation or warranty as to the accuracy of such information. Efforts are underway to better integrate information from third parties. TI has taken and continues to take reasonable steps to provide representative and accurate information but may not have conducted destructive testing or chemical analysis on incoming materials and chemicals. TI and TI suppliers consider certain information to be proprietary, and thus CAS numbers and other limited information may not be available for release.

In no event shall TI's liability arising out of such information exceed the total purchase price of the TI part(s) at issue in this document sold by TI to Customer on an annual basis.

TAPE AND REEL INFORMATION

QUADRANT ASSIGNMENTS FOR PIN 1 ORIENTATION IN TAPE

*All dimensions are nominal

Device	Package Type	Package Drawing	Pins	SPQ	Reel Diameter (mm)	Reel Width W1 (mm)	A0 (mm)	B0 (mm)	K0 (mm)	P1 (mm)	W (mm)	Pin1 Quadrant
LM3526MX-H/NOPB	SOIC	D	8	2500	330.0	12.4	6.5	5.4	2.0	8.0	12.0	Q1
LM3526MX-L	SOIC	D	8	2500	330.0	12.4	6.5	5.4	2.0	8.0	12.0	Q1
LM3526MX-L/NOPB	SOIC	D	8	2500	330.0	12.4	6.5	5.4	2.0	8.0	12.0	Q1

TAPE AND REEL BOX DIMENSIONS

*All dimensions are nominal

Device	Package Type	Package Drawing	Pins	SPQ	Length (mm)	Width (mm)	Height (mm)
LM3526MX-H/NOPB	SOIC	D	8	2500	367.0	367.0	35.0
LM3526MX-L	SOIC	D	8	2500	367.0	367.0	35.0
LM3526MX-L/NOPB	SOIC	D	8	2500	367.0	367.0	35.0

D (R-PDSO-G8)

PLASTIC SMALL OUTLINE



IMPORTANT NOTICE

Texas Instruments Incorporated and its subsidiaries (TI) reserve the right to make corrections, enhancements, improvements and other changes to its semiconductor products and services per JESD46, latest issue, and to discontinue any product or service per JESD48, latest issue. Buyers should obtain the latest relevant information before placing orders and should verify that such information is current and complete. All semiconductor products (also referred to herein as "components") are sold subject to TI's terms and conditions of sale supplied at the time of order acknowledgment.

TI warrants performance of its components to the specifications applicable at the time of sale, in accordance with the warranty in TI's terms and conditions of sale of semiconductor products. Testing and other quality control techniques are used to the extent TI deems necessary to support this warranty. Except where mandated by applicable law, testing of all parameters of each component is not necessarily performed.

TI assumes no liability for applications assistance or the design of Buyers' products. Buyers are responsible for their products and applications using TI components. To minimize the risks associated with Buyers' products and applications, Buyers should provide adequate design and operating safeguards.

TI does not warrant or represent that any license, either express or implied, is granted under any patent right, copyright, mask work right, or other intellectual property right relating to any combination, machine, or process in which TI components or services are used. Information published by TI regarding third-party products or services does not constitute a license to use such products or services or a warranty or endorsement thereof. Use of such information may require a license from a third party under the patents or other intellectual property of the third party, or a license from TI under the patents or other intellectual property of TI.

Reproduction of significant portions of TI information in TI data books or data sheets is permissible only if reproduction is without alteration and is accompanied by all associated warranties, conditions, limitations, and notices. TI is not responsible or liable for such altered documentation. Information of third parties may be subject to additional restrictions.

Resale of TI components or services with statements different from or beyond the parameters stated by TI for that component or service voids all express and any implied warranties for the associated TI component or service and is an unfair and deceptive business practice. TI is not responsible or liable for any such statements.

Buyer acknowledges and agrees that it is solely responsible for compliance with all legal, regulatory and safety-related requirements concerning its products, and any use of TI components in its applications, notwithstanding any applications-related information or support that may be provided by TI. Buyer represents and agrees that it has all the necessary expertise to create and implement safeguards which anticipate dangerous consequences of failures, monitor failures and their consequences, lessen the likelihood of failures that might cause harm and take appropriate remedial actions. Buyer will fully indemnify TI and its representatives against any damages arising out of the use of any TI components in safety-critical applications.

In some cases, TI components may be promoted specifically to facilitate safety-related applications. With such components, TI's goal is to help enable customers to design and create their own end-product solutions that meet applicable functional safety standards and requirements. Nonetheless, such components are subject to these terms.

No TI components are authorized for use in FDA Class III (or similar life-critical medical equipment) unless authorized officers of the parties have executed a special agreement specifically governing such use.

Only those TI components which TI has specifically designated as military grade or "enhanced plastic" are designed and intended for use in military/aerospace applications or environments. Buyer acknowledges and agrees that any military or aerospace use of TI components which have **not** been so designated is solely at the Buyer's risk, and that Buyer is solely responsible for compliance with all legal and regulatory requirements in connection with such use.

TI has specifically designated certain components as meeting ISO/TS16949 requirements, mainly for automotive use. In any case of use of non-designated products, TI will not be responsible for any failure to meet ISO/TS16949.

Products

Audio	www.ti.com/audio
Amplifiers	amplifier.ti.com
Data Converters	dataconverter.ti.com
DLP® Products	www.dlp.com
DSP	dsp.ti.com
Clocks and Timers	www.ti.com/clocks
Interface	interface.ti.com
Logic	logic.ti.com
Power Mgmt	power.ti.com
Microcontrollers	microcontroller.ti.com
RFID	www.ti-rfid.com
OMAP Applications Processors	www.ti.com/omap
Wireless Connectivity	www.ti.com/wirelessconnectivity

Applications

Automotive and Transportation	www.ti.com/automotive
Communications and Telecom	www.ti.com/communications
Computers and Peripherals	www.ti.com/computers
Consumer Electronics	www.ti.com/consumer-apps
Energy and Lighting	www.ti.com/energy
Industrial	www.ti.com/industrial
Medical	www.ti.com/medical
Security	www.ti.com/security
Space, Avionics and Defense	www.ti.com/space-avionics-defense
Video and Imaging	www.ti.com/video

TI E2E Community

e2e.ti.com